

HIKOKI

DH 14DSL • DH 18DSL

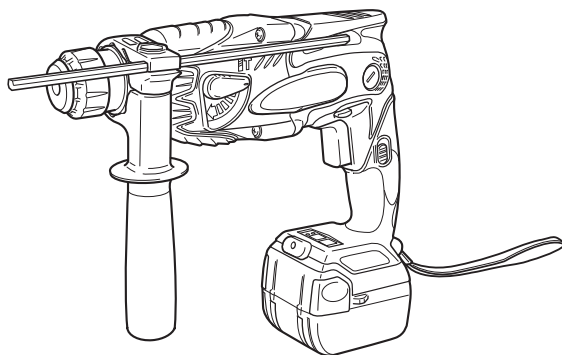

DH14DSL



Handling instructions

GENERAL POWER TOOL SAFETY WARNINGS

WARNING

Read all safety warnings and all instructions.

Failure to follow the warnings and instructions may result in electric shock, fire and/or serious injury.

Save all warnings and instructions for future reference.

The term "power tool" in the warnings refers to your mains-operated (corded) power tool or battery-operated (cordless) power tool.

1) Work area safety

- a) **Keep work area clean and well lit.**
Cluttered or dark areas invite accidents.
- b) **Do not operate power tools in explosive atmospheres, such as in the presence of flammable liquids, gases or dust.**
Power tools create sparks which may ignite the dust or fumes.
- c) **Keep children and bystanders away while operating a power tool.**
Distractions can cause you to lose control.

2) Electrical safety

- a) **Power tool plugs must match the outlet. Never modify the plug in any way. Do not use any adapter plugs with earthed (grounded) power tools.**
Unmodified plugs and matching outlets will reduce risk of electric shock.
- b) **Avoid body contact with earthed or grounded surfaces, such as pipes, radiators, ranges and refrigerators.**
There is an increased risk of electric shock if your body is earthed or grounded.
- c) **Do not expose power tools to rain or wet conditions.**
Water entering a power tool will increase the risk of electric shock.
- d) **Do not abuse the cord. Never use the cord for carrying, pulling or unplugging the power tool. Keep cord away from heat, oil, sharp edges or moving parts.**
Damaged or entangled cords increase the risk of electric shock.
- e) **When operating a power tool outdoors, use an extension cord suitable for outdoor use.**
Use of a cord suitable for outdoor use reduces the risk of electric shock.
- f) **If operating a power tool in a damp location is unavoidable, use a residual current device (RCD) protected supply.**
Use of an RCD reduces the risk of electric shock.

3) Personal safety

- a) **Stay alert, watch what you are doing and use common sense when operating a power tool. Do not use a power tool while you are tired or under the influence of drugs, alcohol or medication.**
A moment of inattention while operating power tools may result in serious personal injury.
- b) **Use personal protective equipment. Always wear eye protection.**
Protective equipment such as dust mask, non-skid safety shoes, hard hat, or hearing protection used for appropriate conditions will reduce personal injuries.
- c) **Prevent unintentional starting. Ensure the switch is in the off position before connecting to**

power source and/or battery pack, picking up or carrying the tool.

Carrying power tools with your finger on the switch or energising power tools that have the switch on invites accidents.

- d) **Remove any adjusting key or wrench before turning the power tool on.**
A wrench or a key left attached to a rotating part of the power tool may result in personal injury.
 - e) **Do not overreach. Keep proper footing and balance at all times.**
This enables better control of the power tool in unexpected situations.
 - f) **Dress properly. Do not wear loose clothing or jewellery. Keep your hair, clothing and gloves away from moving parts.**
Loose clothes, jewellery or long hair can be caught in moving parts.
 - g) **If devices are provided for the connection of dust extraction and collection facilities, ensure these are connected and properly used.**
Use of dust collection can reduce dust-related hazards.
- #### 4) Power tool use and care
- a) **Do not force the power tool. Use the correct power tool for your application.**
The correct power tool will do the job better and safer at the rate for which it was designed.
 - b) **Do not use the power tool if the switch does not turn it on and off.**
Any power tool that cannot be controlled with the switch is dangerous and must be repaired.
 - c) **Disconnect the plug from the power source and/or the battery pack from the power tool before making any adjustments, changing accessories, or storing power tools.**
Such preventive safety measures reduce the risk of starting the power tool accidentally.
 - d) **Store idle power tools out of the reach of children and do not allow persons unfamiliar with the power tool or these instructions to operate the power tool.**
Power tools are dangerous in the hands of untrained users.
 - e) **Maintain power tools. Check for misalignment or binding of moving parts, breakage of parts and any other condition that may affect the power tool's operation. If damaged, have the power tool repaired before use.**
Many accidents are caused by poorly maintained power tools.
 - f) **Keep cutting tools sharp and clean.**
Properly maintained cutting tools with sharp cutting edges are less likely to bind and are easier to control.
 - g) **Use the power tool, accessories and tool bits etc. in accordance with these instructions, taking into account the working conditions and the work to be performed.**
Use of the power tool for operations different from those intended could result in a hazardous situation.
- #### 5) Battery tool use and care
- a) **Recharge only with the charger specified by the manufacturer.**
A charger that is suitable for one type of battery pack may create a risk of fire when used with another battery pack.
 - b) **Use power tools only with specifically designated battery packs.**
Use of any other battery packs may create a risk of injury and fire.

- c) **When battery pack is not in use, keep it away from other metal objects, like paper clips, coins, keys, nails, screws or other small metal objects, that can make a connection from one terminal to another.**
Shorting the battery terminals together may cause burns or a fire.
 - d) **Under abusive conditions, liquid may be ejected from the battery; avoid contact. If contact accidentally occurs, flush with water. If liquid contacts eyes, additionally seek medical help.**
Liquid ejected from the battery may cause irritation or burns.
- 6) **Service**
- a) **Have your power tool serviced by a qualified repair person using only identical replacement parts.**
This will ensure that the safety of the power tool is maintained.

PRECAUTION

Keep children and infirm persons away. When not in use, tools should be stored out of reach of children and infirm persons.

CORDLESS ROTARY HAMMER SAFETY WARNINGS

1. **Wear ear protectors**
Exposure to noise can cause hearing loss.
 2. **Use auxiliary handle(s), if supplied with the tool.**
Loss of control can cause personal injury.
 3. **Hold power tool by insulated gripping surfaces, when performing an operation where the cutting accessory may contact hidden wiring.**
Cutting accessory contacting a "live" wire may make exposed metal parts of the power tool "live" and could give the operator an electric shock.
10. Do not touch the bit during or immediately after operation. The bit becomes very hot during operation and could cause serious burns.
 11. Always hold the body handle and side handle of the power tool firmly. Otherwise the counterforce produced may result in inaccurate and even dangerous operation.
 12. Wear a dust mask
Do not inhale the harmful dusts generated in drilling or chiseling operation. The dust can endanger the health of yourself and bystanders.
 13. Make sure that the battery is installed firmly. If it is at all loose it could come off and cause an accident.
 14. To prevent accidents, make sure to turn the switch off and pull out the battery before changing accessories, storing, carrying or when not using the tools.
 15. Mounting the drill bit
 - To prevent accidents, make sure to turn the switch off and pull out the battery.
 - When using tools such as bull points, drill bits, etc., make sure to use the genuine parts designated by our company.
 - Clean the shank portion of the drill bit.
 - Check the latching by pulling on the drill bit.
 16. Operate the change lever only when the motor is at a full stop. Operating the change lever while the motor is running may cause the tip tool to unexpectedly rotate and result in an accident. (Fig. 7)
 17. Rotation + hammering
When the drill bit touches construction iron bar, the bit will stop immediately and the rotary hammer will react to revolve. Therefore firmly tighten the side handle, hold the body handle and side handles.
 18. Rotation only
 - To drill wood or metal material using the drill chuck and chuck adapter (optional accessories).
 - Application of force more than necessary will not only expedite the work at all, but will deteriorate the tip edge of the drill bit and reduce the service life of the rotary hammer in addition.
 - Drill bits may snap off while withdrawing the rotary hammer from the drilled hole. For withdrawing, it is important to use a pushing motion.
 - Do not attempt to drill anchor holes or holes in concrete with the machine set in the rotation only function.
 - Do not attempt to use the rotary hammer in the rotation and striking mode with the drill chuck and chuck adapter attached. This would seriously shorten the service life of every component of the machine.
 19. Selecting the Power / Save mode
 - The hammering force of the hammer can be increased or decreased to conform with intended usage, by operating the shift knob as per Fig. 10. Adjust the force to match the usage intended.
 - Do not drill holes in wood with the "SAVE" mode. There is a likelihood that the motor will burn out because it can easily lock up due to the low power.
 20. Do not look directly into the light. Such actions could result in eye injury.
 21. To prevent the battery power consumption caused by forgetting to turn off the LED light, the light goes off automatically in about 15 minutes.

ADDITIONAL SAFETY WARNINGS

1. Do not allow foreign matter to enter the hole for connecting the rechargeable battery.
2. Never disassemble the rechargeable battery and charger.
3. Never short-circuit the rechargeable battery. Shortcircuiting the battery will cause a great electric current and overheat. It results in burn or damage to the battery.
4. Do not dispose of the battery in fire. If the battery is burnt, it may explode.
5. When using this unit continuously, the unit may overheat, leading to damage in the motor and switch. Please leave it without using it for approximately 15 minutes.
6. Do not insert object into the air ventilation slots of the charger. Inserting metal objects or inflammables into the charger air ventilation slots will result in electrical shock hazard or damaged charger.
7. Bring the battery to the shop from which it was purchased as soon as the post-charging battery life becomes too short for practical use. Do not dispose of the exhausted battery.
8. Before starting to break, chip or drill into a wall, floor or ceiling, thoroughly confirm that such items as electric cables or conduits are not buried inside.
9. Ensure that the power switch is in the OFF position. If the battery is installed while the power switch is in the ON position, the power tool will start operating immediately, which could cause a serious accident.

CAUTION ON LITHIUM-ION BATTERY

To extend the lifetime, the lithium-ion battery equips with the protection function to stop the output. In the cases of 1 to 3 described below, when using this product, even if you are pulling the switch, the motor may stop. This is not the trouble but the result of protection function.

1. When the battery power remaining runs out, the motor stops.
In such a case, charge it up immediately.
2. If the tool is overloaded, the motor may stop. In this case, release the switch of tool and eliminate causes of overloading. After that, you can use it again.
3. If the battery is overheated under overload work, the battery power may stop.
In this case, stop using the battery and let the battery cool. After that, you can use it again.

Furthermore, please heed the following warning and caution.

WARNING

In order to prevent any battery leakage, heat generation, smoke emission, explosion and ignition beforehand, please be sure to heed the following precautions.

1. Make sure that swarf and dust do not collect on the battery.
- During work make sure that swarf and dust do not fall on the battery.
- Make sure that any swarf and dust falling on the power tool during work do not collect on the battery.
- Do not store an unused battery in a location exposed to swarf and dust.
- Before storing a battery, remove any swarf and dust that may adhere to it and do not store it together with metal parts (screws, nails, etc.).
2. Do not pierce battery with a sharp object such as a nail, strike with a hammer, step on, throw or subject the battery to severe physical shock.
3. Do not use an apparently damaged or deformed battery.
4. Do not use the battery in reverse polarity.
5. Do not connect directly to an electrical outlets or car cigarette lighter sockets.
6. Do not use the battery for a purpose other than those specified.
7. If the battery charging fails to complete even when a specified recharging time has elapsed, immediately stop further recharging.
8. Do not put or subject the battery to high temperatures or high pressure such as into a microwave oven, dryer, or high pressure container.
9. Keep away from fire immediately when leakage or foul odor are detected.
10. Do not use in a location where strong static electricity generates.
11. If there is battery leakage, foul odor, heat generated, discolored or deformed, or in any way appears abnormal during use, recharging or storage, immediately remove it from the equipment or battery charger, and stop use.

CAUTION

1. If liquid leaking from the battery gets into your eyes, do not rub your eyes and wash them well with fresh clean water such as tap water and contact a doctor immediately.
If left untreated, the liquid may cause eye-problems.
2. If liquid leaks onto your skin or clothes, wash well with clean water such as tap water immediately.
There is a possibility that this can cause skin irritation.
3. If you find rust, foul odor, overheating, discolor, deformation, and/or other irregularities when using the battery for the first time, do not use and return it to your supplier or vendor.

WARNING

If a conductive foreign matter enters in the terminal of lithium ion battery, the battery may be shorted, causing fire. When storing the lithium ion battery, obey surely the rules of following contents.

- Do not place conductive debris, nail and wires such as iron wire and copper wire in the storage case.
- To prevent shorting from occurring, load the battery in the tool or insert securely the battery cover for storing until the ventilator is not seen.

REGARDING LITHIUM-ION BATTERY TRANSPORTATION

When transporting a lithium-ion battery, please observe the following precautions.

WARNING

Notify the transporting company that a package contains a lithium-ion battery, inform the company of its power output and follow the instructions of the transportation company when arranging transport.

- Lithium-ion batteries that exceed a power output of 100Wh are considered to be in the freight classification of Dangerous Goods and will require special application procedures.
- For transportation abroad, you must comply with international law and the rules and regulations of the destination country.

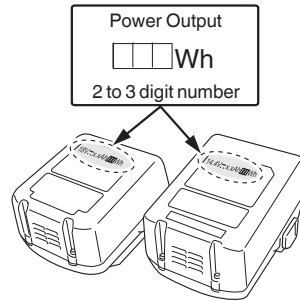

USB DEVICE CONNECTION PRECAUTIONS (ONLY WITH UC18YSL3 CHARGER)

When an unexpected problem occurs, the data in a USB device connected to this product may be corrupted or lost. Always make sure to back up any data contained in the USB device prior to use with this product.

Please be aware that our company accepts absolutely no responsibility for any data stored in a USB device that is corrupted or lost, nor for any damage that may occur to a connected device.

WARNING

- Prior to use, check the connecting USB cable for any defect or damage.
Using a defective or damaged USB cable can cause smoke emission or ignition.
- When the product is not being used, cover the USB port with the rubber cover.
Buildup of dust etc. in the USB port can cause smoke emission or ignition.











NOTE









- There may be an occasional pause during USB recharging.
- When a USB device is not being charged, remove the USB device from the charger.
Failure to do so may not only reduce the battery life of a USB device, but may also result in unexpected accidents.
- It may not be possible to charge some USB devices, depending on the type of device.

SYMBOLS

WARNING

The following show symbols used for the machine. Be sure that you understand their meaning before use.

	DH14DSL / DH18DSL: Cordless Rotary Hammer
	Read all safety warnings and all instructions.
V	Rated voltage
n_0	No-load speed
Pm	Power mode
Sm	Save mode
	Concrete
	Steel
	Wood
	Rotation only function
	Rotation and hammering function
	Switching ON
	Switching OFF
	Disconnect the battery

	Light switch
	Remaining battery indicator switch
	Clockwise rotation
	Counterclockwise rotation
	The battery remaining power is nearly empty. Recharge the battery soonest possible
	The battery remaining power is a half.
	The battery remaining power is enough.
	Prohibited action

STANDARD ACCESSORIES

In addition to the main unit (1 unit), the package contains the accessories listed in **Table 3** on page 9.

Standard accessories are subject to change without notice.

APPLICATIONS

Rotation and hammering function 

- Drilling anchor holes
- Drilling holes in concrete
- Drilling holes in tile

Rotation only function 

- Drilling in steel or wood (with optional accessories)
- Tightening machine screws, wood screws (with optional accessories)

SPECIFICATIONS

Model		DH14DSL	DH18DSL
Voltage		14.4 V	18 V
No-Load Speed (Save/Power)		0 – 750 /min / 0 – 1500 /min	
Full-load impact rate (Save/Power)		0 – 3100 /min / 0 – 6200 /min	
Capacity	Drilling	Concrete	16 mm
		Steel	13 mm
		Wood	18 mm
Weight		2.1 kg	2.2 kg

NOTE

Due to HiKOKI's continuing program of research and development, the specifications herein are subject to change without prior notice.

CHARGING

Before using the power tool, charge the battery as follows.

1. Connect to the power source. (Fig. 2)

When charging the battery from an AC power source

- Connect the charger's power cord to the receptacle.

<UC18YFSL, UC18YML2>

When connecting the plug of the charger to a receptacle, the pilot lamp will blink in red (At 1-second intervals).

<UC18YSL3>

When connecting the plug of the charger to a receptacle, the charge indicator lamp will blink in red (At 1-second intervals).

CAUTION

Do not use the electrical cord if damaged. Have it repaired immediately.

When charging the battery from a DC 12V in-car power source (UC18YML2)

- Secure the battery charger in place in the car.

Use the strap supplied with the battery charger to fasten the battery charger in place and prevent it from moving inadvertently. (See Fig. 17)

CAUTION

Do not place the battery charger or battery under the driver's seat. Secure the battery charger in place to prevent it from moving inadvertently as this may lead to an accident.



Fig. 17

- Insert the cigarette lighter connecting plug into the cigarette lighter socket.
If the plug is loose and falls out of the cigarette lighter socket, repair the socket. As the socket may be faulty, you are recommended to contact your local car dealer. Continued use of the socket may result in an accident due to overheating.

2. Insert the battery into the charger. (Fig. 2)

Firmly insert the battery into the charger.

3. Charging

<UC18YFSL, UC18YML2>

When inserting a battery in the charger, the pilot lamp will light up continuously in red.

When the battery becomes fully recharged, the pilot lamp will blink in red (At 1-second intervals). (See **Table 1-a**)

- Pilot lamp indication

The indications of the pilot lamp will be as shown in **Table 1-a**, according to the condition of the charger or the rechargeable battery.

<UC18YSL3>

When inserting a battery in the charger, the charge indicator lamp will blink in blue.

When the battery becomes fully recharged, the charge indicator lamp will light up in green. (See **Table 1-b**)

- Charge indicator lamp indication

The indications of the charge indicator lamp will be as shown in **Table 1-b**, according to the condition of the charger or the rechargeable battery.

Table 1-a

Indications of the pilot lamp				
The pilot lamp lights or blinks.	Before charging	Blinks (red)	Lights for 0.5 seconds. Does not light for 0.5 seconds. (off for 0.5 seconds)	
	While charging	Lights (red)	Lights continuously	
	Charging complete	Blinks (red)	Lights for 0.5 seconds. Does not light for 0.5 seconds. (off for 0.5 seconds)	
	Charging impossible	Flickers (red)	Lights for 0.1 seconds. Does not light for 0.1 seconds. (off for 0.1 seconds)	Malfunction in the battery or the charger
	Overheat standby	Lights (green) (UC18YML2)	Lights continuously	Battery overheated. Unable to charge. (Charging will commence when battery cools)
		Blinks (red) (UC18YFSL)	Lights for 1 second. Does not light for 0.5 seconds. (off for 0.5 seconds)	
Charging with in-car power source impossible (UC18YML2)	Blinks (green)	Lights for 0.5 seconds. Does not light for 0.5 seconds. (off for 0.5 seconds)	Malfunction in the battery or the charger	

NOTE: When standby for cooling battery, UC18YML2 / UC18YFSL cools the overheated battery by cooling fan. (However, the cooling fan does not function when charging the battery with a DC 12V in-car power source.)

Table 1-b

Indications of the charge indicator lamp				
Charge indicator lamp (red / blue / green / purple)	Before charging	Blinks (red)	Lights for 0.5 seconds. Does not light for 0.5 seconds. (off for 0.5 seconds)	Plugged into power source
	While charging	Blinks (blue)	Lights for 0.5 seconds. Does not light for 1 second. (off for 1 second)	Battery capacity at less than 50%
		Blinks (blue)	Lights for 1 second. Does not light for 0.5 seconds. (off for 0.5 seconds)	Battery capacity at less than 80%
		Lights (blue)	Lights continuously	Battery capacity at more than 80%
	Charging complete	Lights (green)	Lights continuously (Continuous buzzer sound: about 6 seconds)	
	Overheat standby	Blinks (red)	Lights for 0.3 seconds. Does not light for 0.3 seconds. (off for 0.3 seconds)	Battery overheated. Unable to charge. (Charging will commence when battery cools)
	Charging impossible	Flickers (purple)	Lights for 0.1 seconds. Does not light for 0.1 seconds. (off for 0.1 seconds) (Intermittent buzzer sound: about 2 seconds)	Malfunction in the battery or the charger

NOTE: When standby for cooling battery, UC18YSL3 cools the overheated battery by cooling fan.

- Regarding the temperatures and charging time of the battery
The temperatures and charging time will become as shown in **Table 2**.

Table 2

Battery		Charger	UC18YFSL	UC18YML2 (AC/DC)*1	UC18YSL3
		Charging voltage	V	14.4V – 18V	
Weight	kg	0.5	0.7	0.6	
Temperatures at which the battery can be recharged		0°C – 50°C			-10°C – 50°C
Charging time for battery capacity, approx. (At 20°C)					
1.3 Ah	min.	20	20 / 50	15	
1.5 Ah	min.	22	22 / 60	15	
2.0 Ah	min.	30	30 / 80	20	
2.5 Ah	min.	35	35 / 100	25	
3.0 Ah	min.	45	45 / 120	20	
4.0 Ah	min.	60	60 / 160	26	
5.0 Ah	min.	75	75 / 200	32	
6.0 Ah	min.	90	90 / 240	38	
Number of battery cells		4 – 10			

*1 AC power supply / DC 12V (in-car) power supply

NOTE

The recharging time may vary according to the ambient temperature and power source voltage.

<UC18YML2>

Especially, using a DC 12V in-car power source may require longer recharging time at high temperatures.

CAUTION

When the battery charger has been continuously used, the battery charger will be heated, thus constituting the cause of the failures. Once the charging has been completed, give 15 minutes rest until the next charging.

4. Disconnect the charger's power cord from the receptacle or cigarette lighter socket.
5. Hold the charger firmly and pull out the battery.

NOTE

Be sure to pull out the battery from the charger after use, and then keep it.

CAUTION

- If the battery is charged while it is heated because it has been left for a long time in a location subject to direct sunlight or because the battery has just been used, the pilot lamp of UC18YML2 charger lights up green, or the pilot lamp of UC18YFSL charger lights for 1 second, does not light for 0.5 seconds (off for 0.5 seconds), or the charge indicator lamp of UC18YSL3 charger lights for 0.3 seconds, does not light for 0.3 seconds (off for 0.3 seconds). In such a case, first let the battery cool, then start charging.

- When the pilot lamp or charge indicator lamp flickers in red (at 0.2-seconds intervals), check for and take out any foreign objects in the charger's battery connector. If there are no foreign objects, it is probable that the battery or charger is malfunctioning. Take it to your authorized Service Center.
- Since the built-in micro computer takes about 3 seconds to confirm that the battery being charged with charger is taken out, wait for a minimum of 3 seconds before reinserting it to continue charging. If the battery is reinserted within 3 seconds, the battery may not be properly charged.
- Check the voltage of the in-car power source when the pilot lamp flickers in green (every 0.2 seconds) continuously. (UC18YML2)
If the voltage is 12V or lower, it indicates that the car battery has weakened and cannot be charged.
- If the pilot lamp or charge indicator lamp does not blink in red (every second) even though the charger cord or cigarette lighter connecting plug is connected to the power, it indicates that the protection circuit of the charger may be activated.
Remove the cord or plug from the power and then connect it again after 30 seconds or so. If this does not cause the pilot lamp or charge indicator lamp to blink in red (every second), please take the charger to the HiKOKI Authorized Service Center.

LUBRICATION

Low viscosity grease is applied to this rotary hammer so that it can be used for a long period without replacing the grease. Please contact the nearest service center for grease replacement when any grease is leaking from loosened screw.

Further use of the rotary hammer despite the grease shortage causes damage to reduce the service life.

CAUTION

A specific grease is used with this machine, therefore, the normal performance of the machine may be badly affected by use of different grease. Please be sure to let one of our service centers to undertake replacement of the grease.

MAINTENANCE AND INSPECTION

CAUTION

Be sure to turned off the switch and remove the battery before maintenance and inspection.

1. Inspecting the tool

Since use of as dull tool will degrade efficiency and cause possible motor malfunction, sharpen or replace the tool as soon as abrasion is noted.

2. Inspecting the mounting screws

Regularly inspect all mounting screws and ensure that they are properly tightened. Should any of the screws be loose, retighten them immediately. Failure to do so could result in serious hazard.

3. Maintenance of the motor

The motor unit winding is the very "heart" of the power tool. Exercise due care to ensure the winding does not become damaged and/or wet with oil or water.

4. Inspecting the carbon brushes (Fig. 13)

The motor employs carbon brushes which are consumable parts. Since and excessively worn carbon brush can result in motor trouble, replace the carbon brush with new ones when it becomes worn to or near the "wear limit" Ⓞ. In addition, always keep carbon brushes clean and ensure that they slide freely within the brush holders.

NOTE

When replacing the carbon brush with a new one, be sure to use the HiKOKI Carbon Brush Code No. 999100.

5. Replacing carbon brushes (Fig. 13)

Take out the carbon brush by first removing the brush cap and then hooking the protrusion of the carbon brush with a flat head screw driver, etc.

When installing the carbon brush, choose the direction so that the nail Ⓞ of the carbon brush agrees with the contact portion Ⓞ outside the brush tube. Then push it in with a finger. Lastly, install the brush cap.

CAUTION

Be absolutely sure to insert the nail of the carbon brush into the contact portion outside the brush tube. (You can insert whichever one of the two nails provided).

Caution must be exercised since any error in this operation can result in the deformed nail of the carbon brush and may cause motor trouble at an early stage.

6. Cleaning on the outside

When the power tool is stained, wipe with a soft dry cloth or a cloth moistened with soapy water. Do not use chloric solvents, gasoline or paint thinner, for they melt plastics.

7. Storage

Store the power tool in a place in which the temperature is less than 40°C and out of reach of children.

NOTE

Storing lithium-ion batteries.

Make sure the lithium-ion batteries have been fully charged before storing them.

MOUNTING AND OPERATION

Action	Figure	Page
Removing and inserting the battery	1	10
Charging	2	10
Installing / Removing the side handle	3	10
Inserting SDS-plus drilling tools	4	11
Removing SDS-plus drilling tools	5	11
Selecting rotation direction	6	11
Selecting the operating mode	7	11
Adjusting the drilling depth	8	11
Selecting the Save/Power mode	9	12
Switch operation	10	12
Remaining battery indicator	11	12
How to use the LED light	12	12
Check and replacing the carbon brush	13	12
Charging a USB device from an electrical outlet	14-a	13
Charging a USB device and battery from an electrical outlet	14-b	13
How to recharge USB device	15	13
When charging of USB device is completed	16	13
Selecting accessories*	—	14, 15

* For detailed information regarding each tool, contact a HiKOKI authorized service center.

Prolonged storage (3 months or more) of batteries with a low charge may result in performance deterioration, significantly reducing battery usage time or rendering the batteries incapable of holding a charge. However, significantly reduced battery usage time may be recovered by repeatedly charging and using the batteries two to five times. If the battery usage time is extremely short despite repeated charging and use, consider the batteries dead and purchase new batteries.

Important notice on the batteries for the HiKOKI cordless power tools
 Please always use one of our designated genuine batteries. We cannot guarantee the safety and performance of our cordless power tool when used with batteries other than these designated by us, or when the battery is disassembled and modified (such as disassembly and replacement of cells or other internal parts).



CAUTION

In the operation and maintenance of power tools, the safety regulations and standards prescribed in each country must be observed.

NOTE

Due to HiKOKI's continuing program of research and development, the specifications herein are subject to change without prior notice.

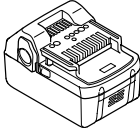
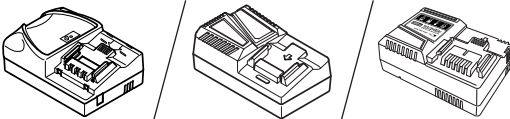
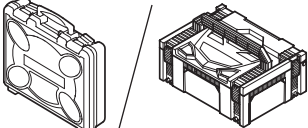
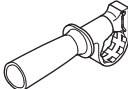
Table 3

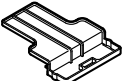
	DH14DSL, DH18DSL	
		(NN)
	2	—
	1	—
	1	—
	1	1
	1	1
	1	—

1

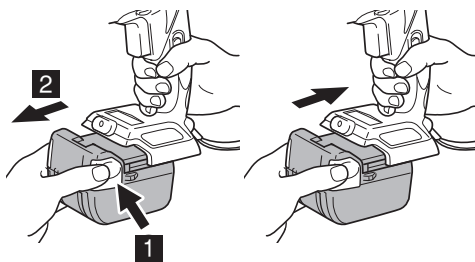

2

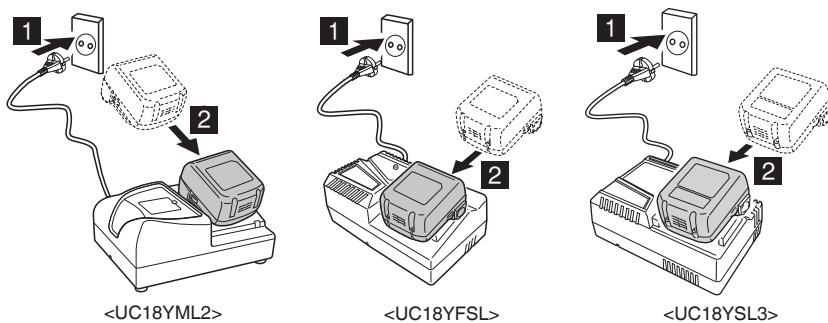

3

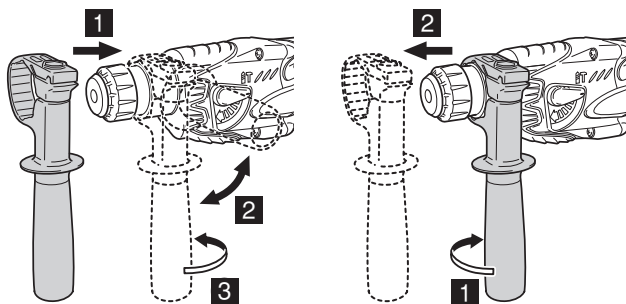

4

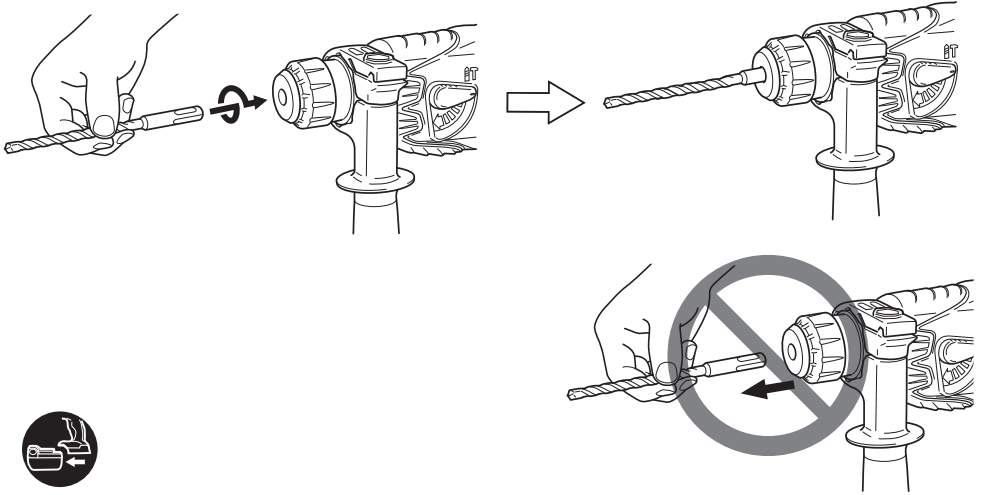

5

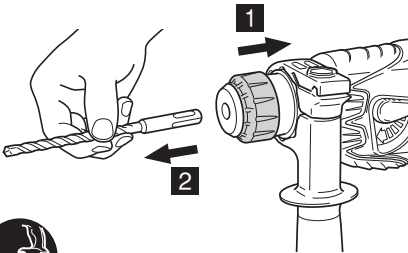

6

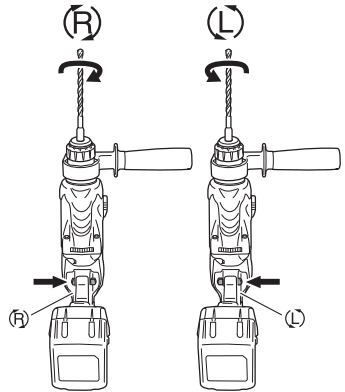

7

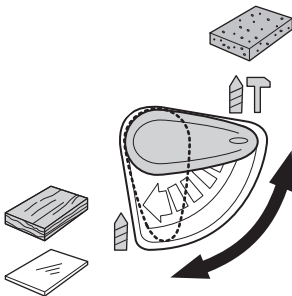

8

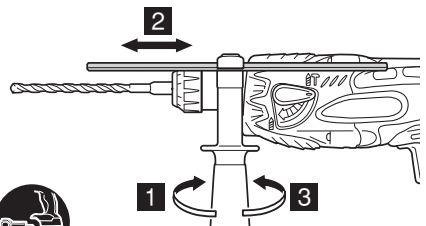

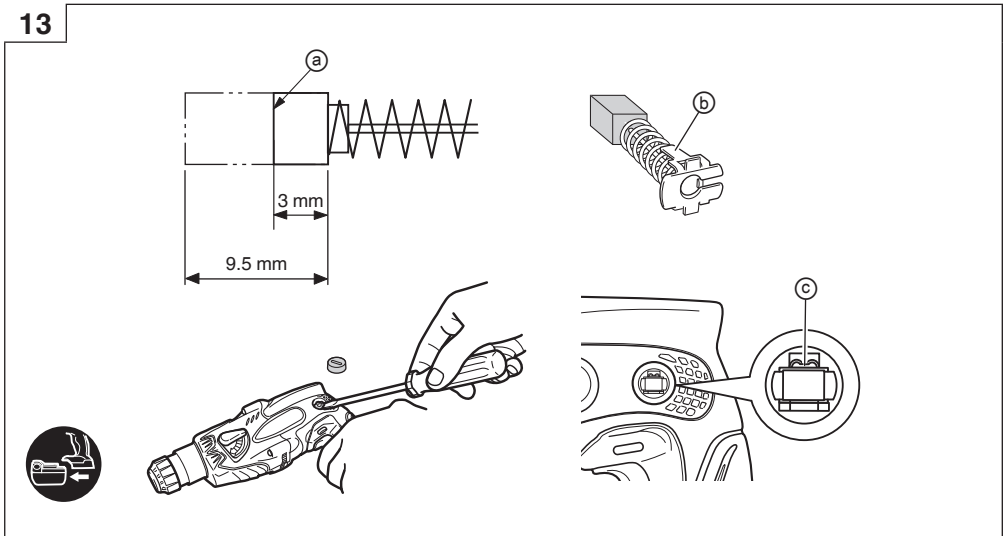
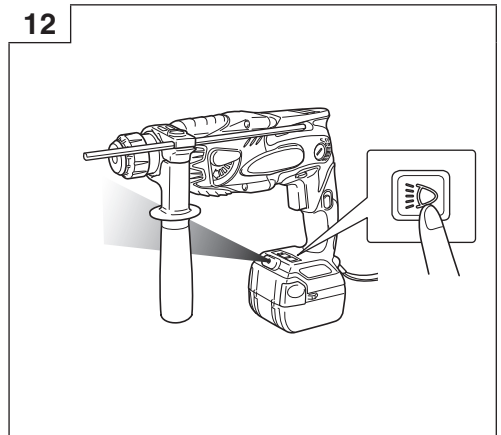
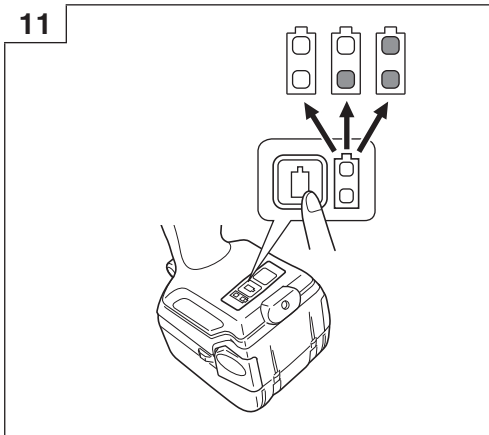
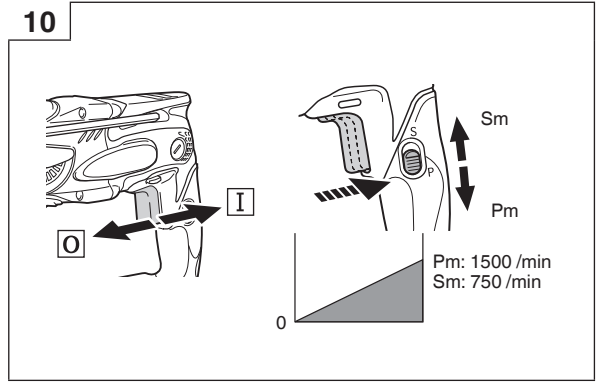
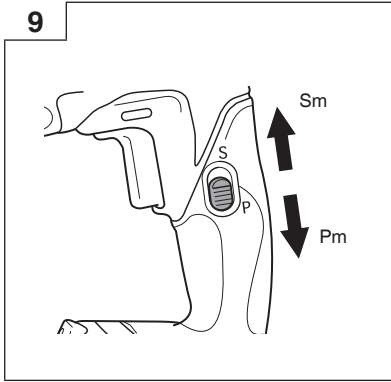

14

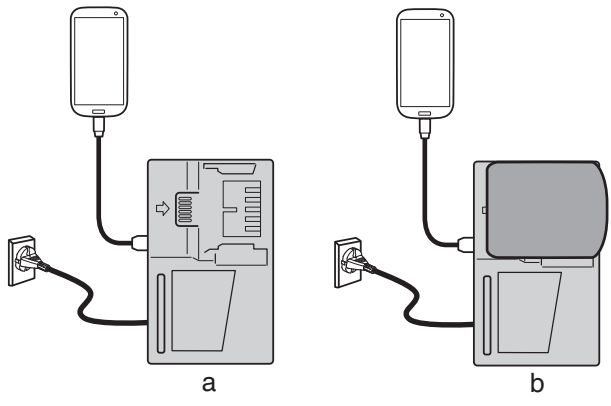

15

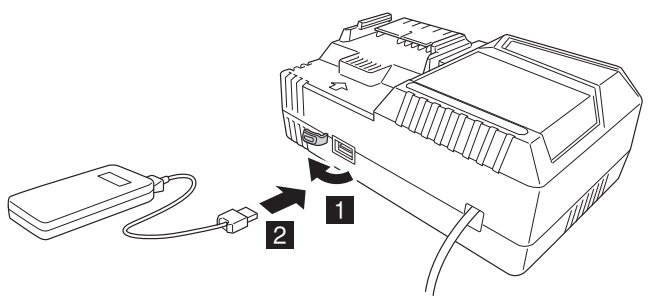

16

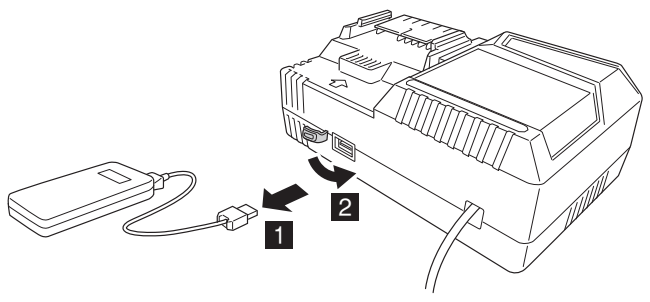

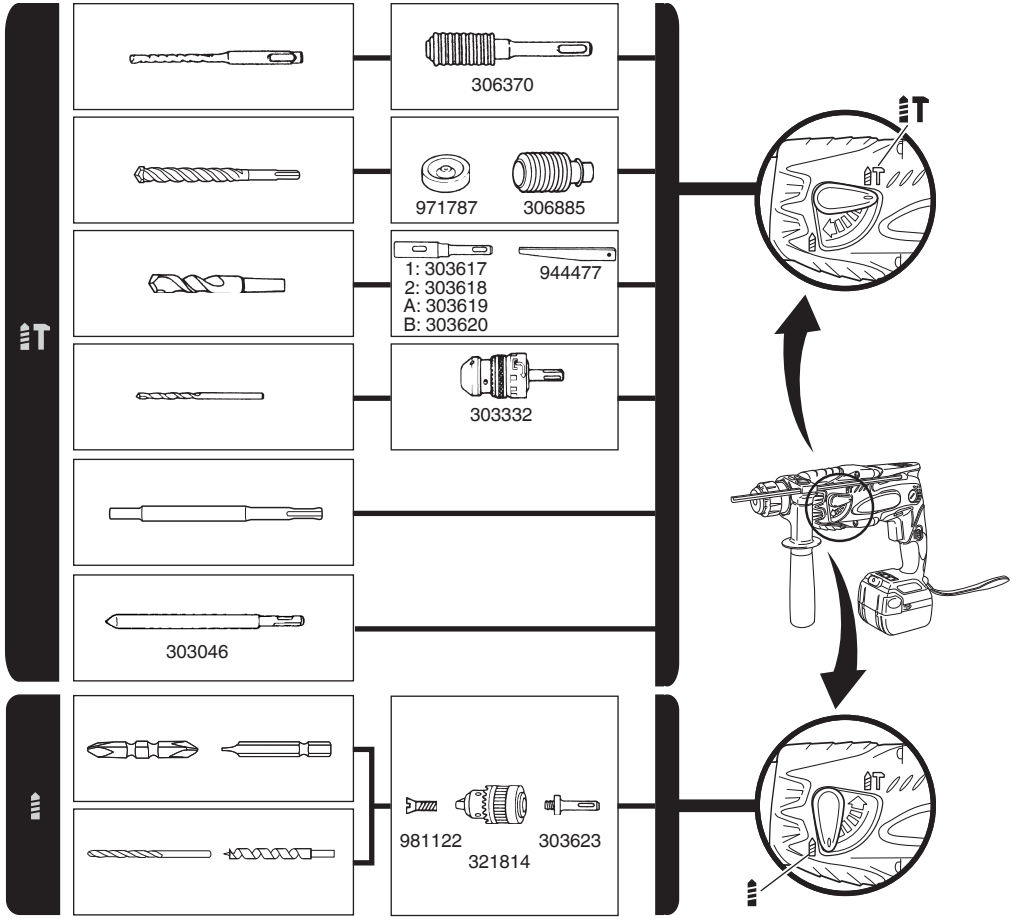

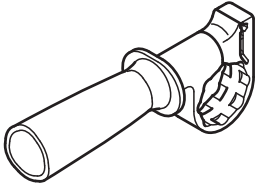

324548

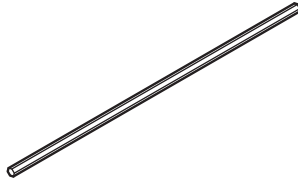

303709

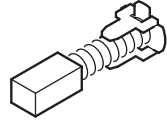

999100

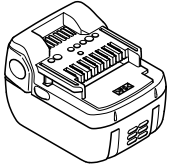

14.4V (Li-ion)

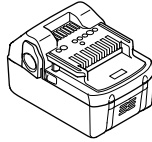
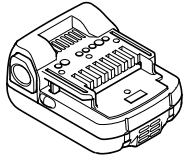

18V (Li-ion)

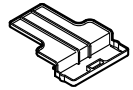
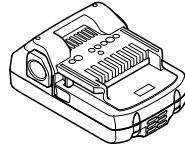

329897

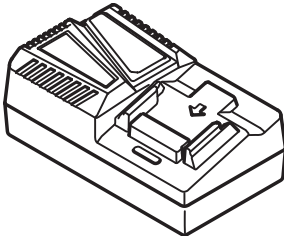

UC18YFSL (14.4V - 18V)

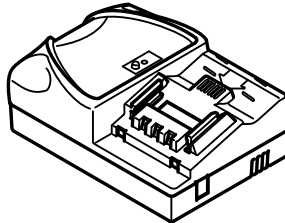

UC18YML2 (14.4V - 18V)

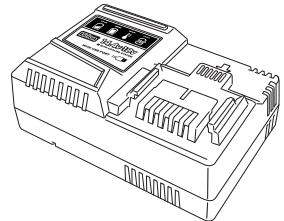

UC18YSL3 (14.4V - 18V)

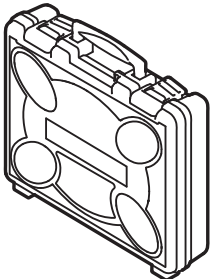

337088

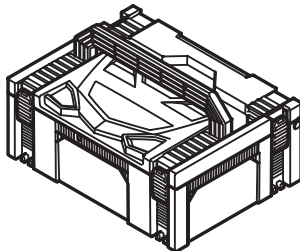

336471

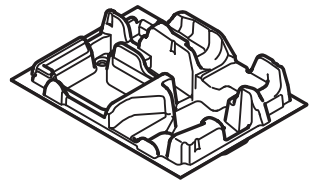

337114

Koki Holdings Co., Ltd.

Shinagawa Intercity Tower A, 15-1, Konan 2-chome,
Minato-ku, Tokyo, Japan